



 Evaporatore per montaggio sottopancia, 3 velocità di ventilazione, termostato regolabile. Disponibile anche con uscita tubi a destra.

 Evaporateur pour montage sous planche, 3 vitesses de ventilation, thermostat réglable. Disponible aussi avec sortie tuyaux à droite.

 Evaporator under dashboard mounted, 3 blower speed, adjustable thermostat. Also available with fittings on right side.

 Verdampfer für die Montage unterhalb vom Armaturenbrett, 3 Gebläsegeschwindigkeiten, Stufenlos regelbarer Thermostat. Auch mit Schlauchausgang an der rechten Seite lieferbar.

 Evaporador para montar debajo del salpicadero, 3 velocidades del ventilador, termostato regulable. También disponible con reacoeres para ser montado al lado derecho.

EVAPORATORE

E 35

12V cod.2020189128/3



EVAPORATORE

E 35

24V cod.2020189129/2

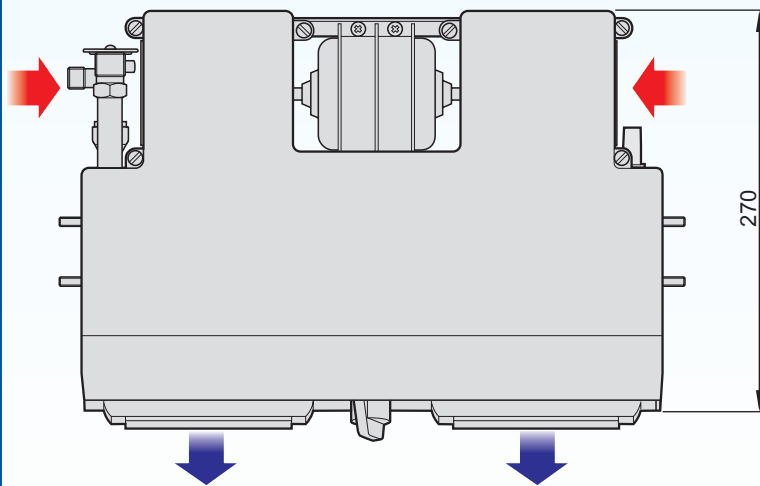
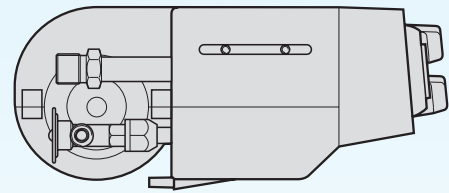
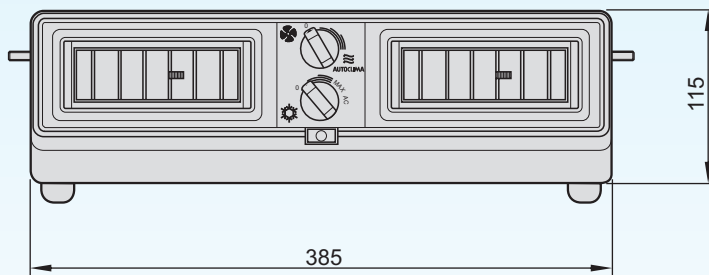

A richiesta è disponibile un kit accessori per la distribuzione remota dell'aria.

Sur demande est disponible un kit accessoires pour la distribution remote de l'air.

Upon request is available an accessories kit for the remote air distribution.

Auf Anfrage ist ein Zubehörkit für die Fernverteilung der Luft lieferbar.

Sobre consulta es posible suministrar un kit acesorios por la distribucion remota de l'aire.

Dati tecnici nominali	Données techniques nominaux	Nominal technical data	Technische Nominal-Eigenheiten	Datos tecnicos	<b>E 35</b>
• Potenza frigorifera	• Puissance frigorifique	• Cooling capacity	• Kälteleistung	• Potencia frigorifica	3 kW
• Tensione alimentazione	• Tension d'alimentation	• Working voltage	• Spannung	• Tension de alimentacion	12Vc.c / 24Vc.c
• Assorbimento elettrico	• Absorption électrique	• Power consumption	• Stromverbrauch	• Intensidad absorbida	12A (12V) / 6A (24V)
• Portata aria	• Débit air	• Air flow	• Gebläseleistung	• Caudal de aire	400 m <sup>3</sup> /h
• Refrigerante	• Réfrigérant	• Coolant	• Kuehlmittel	• Refrigerador	R134a
• Peso	• Poids	• Weight	• Gewicht	• Peso	5,5 Kg

La nostra società si riserva il diritto di migliorare e modificare ciascuno dei modelli illustrati, senza alcun preavviso.

Notre Société se réserve le droit d'améliorer et de modifier sans aucun préavis chacun des modèles ci-illustrés.

The company reserves the right to modify any design in the model without prior notice as per our policy of continuous improvement of design, quality and performance.

Unsere Firma behält sich das Recht vor, jeden Modell hier erlautet ohne Vorankündigung zu ändern und verbessern.

La compañía se reserva el derecho a modificar cualquier diseño en los modelos sin previo aviso debido a la política de continua mejora en el diseño, en la calidad y en el rendimiento



Autoclima S.p.A. - 10020 Cambiano (TO) - ITALY  
Via Cavalieri di Vittorio Veneto, 15 - Tel. 011.94.43.210 - Fax 011.94.43.230  
Internet: <http://www.autoclima.com> e-mail: [sales@autoclima.com](mailto:sales@autoclima.com)

STAMPATO IN ITALIA - RIPRODUZIONE VIETATA

Cod.80819157